



Operation manual

Microcool

MC 250, MC 350, MC 600, MC 1200

Circulation chillers

V7R7

Read this manual prior to performing any task!

°FAHRENHEIT. °CELSIUS. °LAUDA.

Manufacturer

LAUDA DR. R. WOBSER GMBH & CO. KG

Laudaplatz 1

97922 Lauda-Königshofen

Germany

Telephone: +49 (0)9343 503-0

Fax: +49 (0)9343 503-222

E-mail: info@lauda.de

Internet: <https://www.lauda.de>

Translation of the original operation manual

Q4DT-E_13-001, 7, en_US © LAUDA 2021

Replaces issue V7R6, V6R17/16, V5R8, V5R7, V5R5, V4R13, V4R6, V3R20, V3R19, V3R17

7/21/2022

Table of contents

1	Safety.....	6
1.1	General safety instructions.....	6
1.2	Intended Use.....	6
1.3	Foreseeable misuse.....	7
1.4	EMC requirements.....	7
1.5	Prohibition of modifications to the device.....	7
1.6	Requirements for the heat transfer liquid.....	8
1.7	Materials.....	8
1.8	Hose requirements.....	8
1.9	Application area.....	8
1.10	Personnel qualification.....	8
1.11	Personal protective equipment.....	9
1.12	Structure of warnings.....	9
2	Unpacking.....	11
3	Device description.....	12
3.1	Device types.....	12
3.2	Structure of the circulation chiller.....	12
3.3	Operating elements.....	17
3.3.1	Mains switch.....	17
3.3.2	Display buttons.....	17
3.4	Functional elements.....	18
3.4.1	LEDs for function display.....	18
3.4.2	Hydraulic circuit.....	18
3.4.3	Pressure gage.....	19
3.4.4	Level indication.....	19
3.4.5	Cooling unit.....	19
3.4.6	Interfaces.....	20
3.5	Rating label.....	21
4	Before starting up.....	22
4.1	Install device.....	22
4.2	External consuming unit.....	23
4.2.1	Hoses.....	23
4.2.2	Connecting an external consuming unit.....	24
5	Commissioning.....	26
5.1	LAUDA heat transfer liquids.....	26
5.2	Establishing a mains connection.....	27
5.3	Switching on the device and filling with heat transfer liquid.....	27

5.4	Setting the pump pressure.....	29
6	Operation.....	31
6.1	Switching on the device.....	31
6.2	Basic display and menu items.....	31
6.3	Indications in the display.....	33
6.4	Setting the temperature set point.....	33
6.5	Restricting the temperature limits.....	34
6.6	Configuring the clock timer.....	34
6.7	RS 232 interface.....	37
6.7.1	Configuring the RS 232 interface.....	37
6.7.2	Protocol.....	37
6.7.3	Cable test and interface test of RS 232.....	38
6.7.4	Write commands.....	39
6.7.5	Read commands.....	39
6.7.6	Error messages.....	40
6.8	Alarm output.....	40
6.8.1	Configuring the alarm output.....	40
6.8.2	Interface potential-free contact.....	41
6.9	Enter the offset for the temperature probe.....	42
6.10	Restore factory setting.....	42
7	Maintenance.....	44
7.1	General safety instructions.....	44
7.2	Maintenance intervals.....	44
7.3	Cleaning the device.....	45
7.4	Cleaning the air-cooled condenser.....	45
7.5	Check the heat transfer liquid.....	45
8	Faults.....	46
8.1	Alarms, errors and warnings.....	46
8.2	Overview of alarms.....	47
8.3	Overview of warnings.....	47
9	Decommissioning.....	48
9.1	Draining the device.....	48
10	Disposal.....	49
10.1	Disposing of refrigerant.....	49
10.2	Device disposal.....	49
10.3	Disposing of packaging.....	49
11	Technical data.....	50
11.1	General data.....	50
11.2	Cooling unit.....	51

11.3	Refrigerant and filling charge.....	51
11.4	Hydraulic circuit.....	52
11.5	Voltage-dependent data.....	52
12	General.....	53
12.1	Copyright.....	53
12.2	Technical changes.....	53
12.3	Contact LAUDA.....	53
12.4	Declaration of Conformity.....	53
12.5	Product Returns and Clearance Declaration.....	55
13	Index.....	56

1 Safety

1.1 General safety instructions

- The devices can only be operated as intended under the conditions specified in this operating manual. Any other mode of operation is considered to be unintended use and could compromise the protection provided by the device.
- The devices are not designed for use in medical applications in accordance with DIN EN 60601-1 and IEC 601-1!
- This operating manual is part of the device. The information in this operating manual must therefore be kept at hand in the immediate vicinity of the device. Be sure to carefully store this copy of the operating manual.



If this operating manual is lost, contact LAUDA Service Constant Temperature Equipment. You will find the contact information here ↪ Chapter 12.3 “Contact LAUDA” on page 53.

When operating the device, there is a risk of injury from high and low temperatures, fire and the presence of electrical energy. These risks posed by the device have been mitigated in the design to the extent possible in keeping with the applicable norms. The remaining risk can be reduced using one of the following measures:

- If relevant, safety fittings are available for the device. This equipment is critical to the safety of the device. Appropriate maintenance activities must be implemented to ensure the device remains in good working order.
The safety fittings for the device are described in this “Safety” chapter.
- If relevant, various warning symbols are located on the device. These symbols must be observed without fail.
The warning symbols on the device are described in this “Safety” chapter.
- This operating manual contains safety information. This information must be followed at all times.
- Personnel and the protective equipment worn by personnel are also subject to specific requirements.
These requirements are described in this “Safety” chapter.



An overview of authorized personnel and the protective equipment can be found in ↪ Chapter 1.10 “Personnel qualification” on page 8 and ↪ Chapter 1.11 “Personal protective equipment” on page 9.



Refer to ↪ Chapter 1.12 “Structure of warnings” on page 9 for more information on the general structure of safety notices.

1.2 Intended Use

Intended Use

The present device is exclusively permitted to be used for tempering and delivering non-flammable heat transfer liquids in a closed circuit.

Non-intended use

The following applications are considered to be non-intended:

- in potentially explosive areas
- for tempering foodstuffs
- with a glass reactor without overpressure protection

1.3 Foreseeable misuse

Misuse of the device must always be prevented.

Among other things, the following uses are considered to be foreseeable misuse:

- Operation of the device without heat transfer liquid
- Incorrect connection of hoses
- Setting the device up on a tabletop surface, only permitted for MC 250 and MC 350
- Setting an incorrect pump pressure

1.4 EMC requirements

Table 1: Classification in accordance with EMC requirements

Device	Immunity requirements	Emissions class	Customer power supply
Microcool	Table 2 (Industrial) in accordance with DIN EN 61326-1	Emissions Class B in accordance with CISPR 11	Only for EU Domestic connection value ≥ 100 A
Microcool	Table 2 (Industrial) in accordance with DIN EN 61326-1	Emissions Class B in accordance with CISPR 11	Rest of the world (outside EU) No limitation

Instructions for Class A digital device, USA

"This equipment has been tested and found to comply with the limits for Class A digital device, pursuant to Part 15 of the FCC (Federal Communication Commission) Rules. These limits are designed to provide reasonable protection against harmful interference when the equipment is operated in a commercial environment. This equipment generates, uses, and can radiate radio frequency energy and, if not installed and used in accordance with the instruction manual, may cause harmful interference to radio communications. Operation of this equipment in a residential area is likely to cause harmful interference in which case the user will be required to correct the interference at his own expense."

Instructions for Class A digital device, Canada

"This Class A digital apparatus complies with Canadian ICES-003" (ICES = Interference Causing Equipment Standards).

« Cet appareil numérique de la classe A est conforme à la norme NMB-003 du Canada ».

1.5 Prohibition of modifications to the device

Any technical modification of the device by the user is prohibited. Any damage resulting from unauthorized modification is not covered by customer service or the product warranty. Service work may only be performed by the LAUDA Service department or a service partner authorized by LAUDA.

1.6 Requirements for the heat transfer liquid

- Heat transfer liquids are used to control the temperature. LAUDA heat transfer liquids are recommended for the constant temperature equipment. LAUDA heat transfer liquids have been tested by the company LAUDA DR. R. WOBSE GMBH & CO. KG and approved for this device.
- The heat transfer liquids are suitable for a specific temperature range. This temperature range must correspond with the temperature range of your application.
- Hazards caused by high or low temperatures or fire may arise during operation if the heat transfer liquid exceeds or falls below certain temperatures or if the container ruptures causing a reaction with the heat transfer liquid.
- The safety data sheet of the heat transfer liquid specifies hazards and the corresponding safety measures required for handling the liquid. The safety data sheet of the heat transfer liquid must therefore be observed to ensure proper use of the device.
- If you wish to use your own heat transfer liquids, check to ensure that the fluids are compatible with the materials used.
- The heat transfer liquid must be provided with corrosion protection.

1.7 Materials

All parts that come into contact with heat transfer liquid are manufactured from high-quality materials adapted to withstand the operating temperature. High-quality stainless steels and premium-quality heat-resistant plastics are used.

1.8 Hose requirements

The hoses for the external hydraulic circuit must be resistant to:

- the heat transfer liquid used
- the pressure in the hydraulic circuit
- the high and low working temperatures

1.9 Application area

The device may only be used in the following areas:

- Production, quality assurance, research and development in an industrial environment
- Internal areas, not suitable for outdoor installation

1.10 Personnel qualification

Operating personnel

Operating personnel are employees that have been instructed by technical staff in the intended use of the device according to the operating manual.

1.11 Personal protective equipment

Protective clothing

Protective clothing is required for certain activities. This protective clothing must comply with the legal requirements for personal protective equipment. Protective clothing should have long sleeves. Safety footwear is additionally required.

Protective gloves

CE protective gloves are required for certain activities. These protective gloves must comply with the legal requirements for personal protective equipment of the European Union.

Protective goggles

Protective goggles are required for certain activities. These protective goggles must comply with the legal requirements for personal protective equipment of the European Union.

1.12 Structure of warnings

Dangerous

- A warning of "dangerous" indicates an **immediately dangerous** situation.
- If this warning is not observed, then **death** or **severe, irreversible injury** could occur.

	 DANGER! Type and source
	Consequences of not following instructions
	<ul style="list-style-type: none"> ● Measure 1 ● Measure...

Warning

- A warning of "warning" indicates a **possibly dangerous** situation.
- If this warning is not observed, then **death** or **severe, irreversible injury** could occur.

	 WARNING! Type and source
	Consequences of not following instructions
	<ul style="list-style-type: none"> ● Measure 1 ● Measure...

Caution

- A warning of "caution" indicates a **possibly dangerous** situation.
- If this warning is not observed, then **minor, reversible injury** could occur.

 CAUTION! Type and source	
	Consequences of not following instructions
	<ul style="list-style-type: none">● Measure 1● Measure...

Notice

A "notice" warns that dangers to property or the environment may exist.

 NOTICE! Type and source	
	Consequences of not following instructions
	<ul style="list-style-type: none">● Measure 1● Measure...

2 Unpacking



DANGER!
Transport damage

Electric shock

- Closely inspect the device for transport damage prior to commissioning!
- Never operate a device that has sustained transport damage!

Personnel: Operating personnel

1. Unpack the device.

Keep the original packaging of the device for subsequent transportation.

2. Check the device and accessories for completeness and transport damage immediately after delivery.



If the device or accessories are damaged contrary to expectations, immediately inform the shipping company so that a damage report can be compiled and the transport damage inspected. Also notify LAUDA Constant Temperature Equipment Service department immediately. You will find the contact information here ↗ Chapter 12.3 “Contact LAUDA” on page 53.

Table 2: Accessories included as standard

Device type	Designation	Quantity	Catalog number
MC 600, MC 1200	Hose nozzle ¾" with union nut ¾"	2	EOA 004
All devices	Operating manual	1	--

3 Device description

3.1 Device types

The names of the devices consist of the following components.

Component	Description
MC	Microcool
<number>, e.g. 600	Indication of the cooling capacity in watts

Available device types

Device type	Description
MC 250	Air-cooled table-top device with a cooling capacity of 250 watts
MC 350	Air-cooled table-top device with a cooling capacity of 350 watts
MC 600	Air-cooled, floor-standing device with a cooling capacity of 600 watts The pump pressure can be set via a bypass adjusting wheel.
MC 1200	Air-cooled, floor-standing device with a cooling capacity of 1200 watts The pump pressure can be set via a bypass adjusting wheel.

3.2 Structure of the circulation chiller

Note: The illustrations partly show devices in different casing versions. This does not affect the operation.

Front of the MC 250 and MC 350

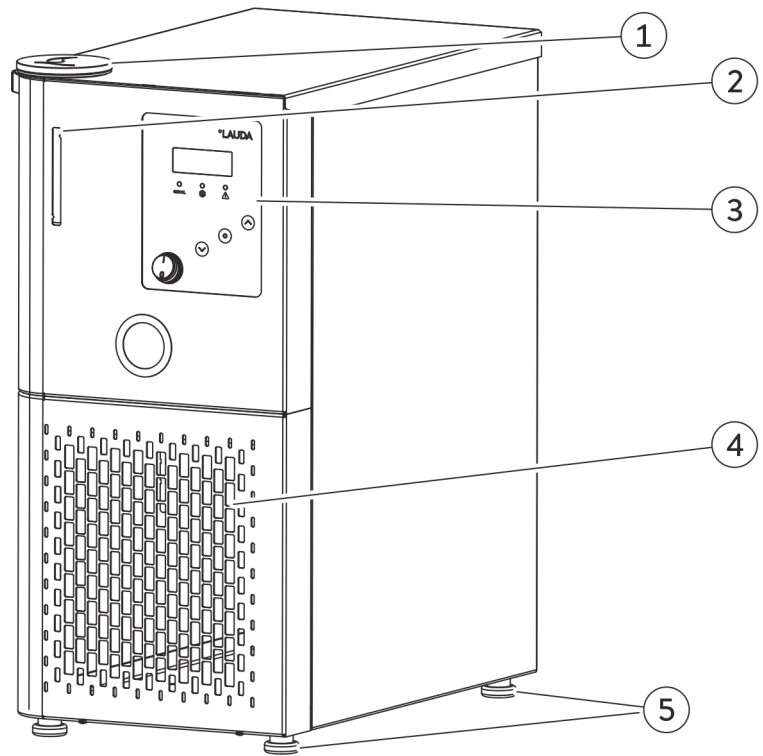

Fig. 1: Overview of the front (MC 350)

- 1 Filler nozzle with cover
- 2 Level indication
- 3 Operating unit
- 4 Front panel with ventilation openings
- 5 Four feet

Back of the MC 250, MC 350

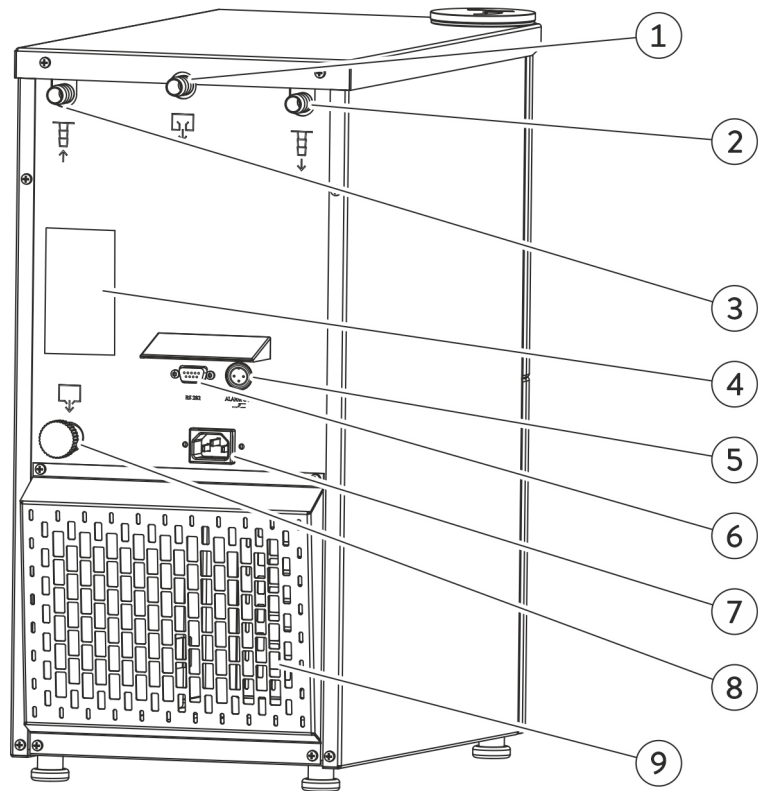

Fig. 2: Overview of the back

- 1 Overflow connection
- 2 Pump connection, outflow
- 3 Pump connection, return flow
- 4 Rating label
- 5 Alarm output
- 6 RS 232 interface
- 7 Power supply
- 8 Drain screw
- 9 Ventilation openings

Front of the MC 600, MC 1200

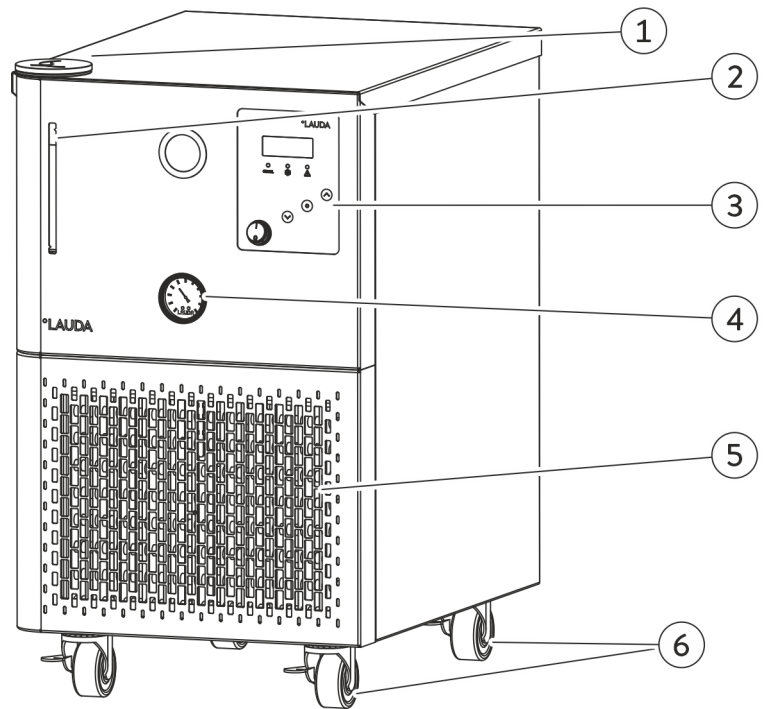

Fig. 3: Overview of the front

- 1 Filler nozzle with cover
- 2 Level indication
- 3 Operating unit
- 4 Pressure gage
- 5 Front panel with ventilation openings
- 6 Four casters with locking brake

Back of the MC 600, MC 1200

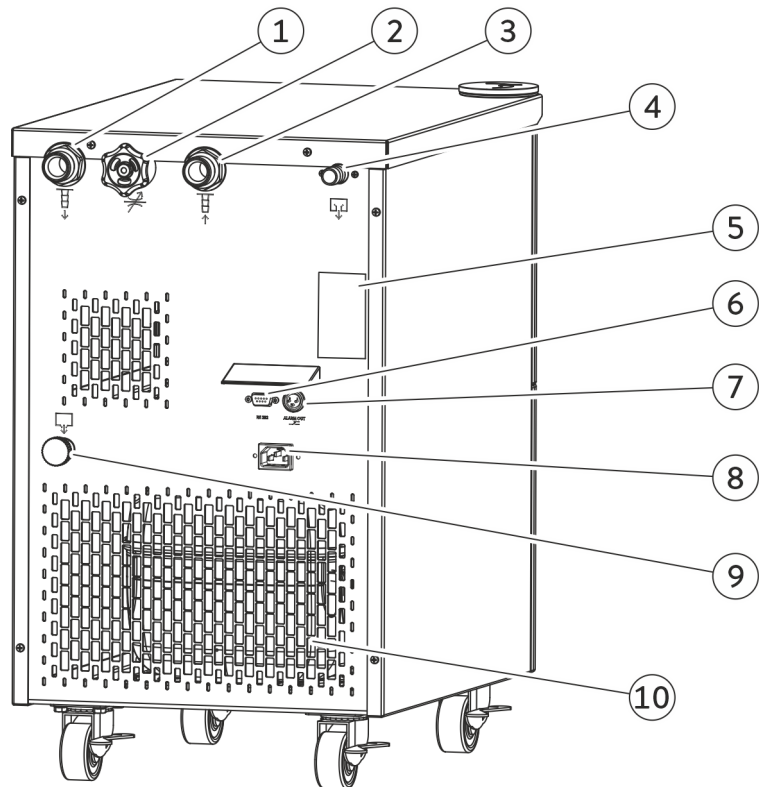
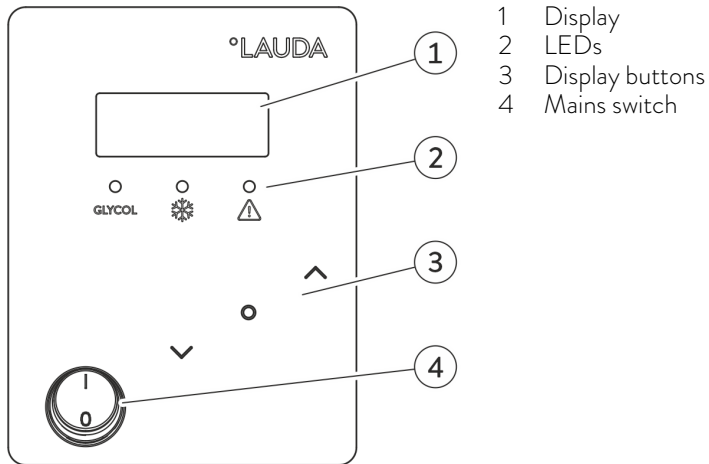

Fig. 4: Overview of the back

- 1 Pump connection, outflow
- 2 Bypass adjusting wheel
- 3 Pump connection, return flow
- 4 Overflow connection
- 5 Rating label
- 6 RS 232 interface
- 7 Alarm output
- 8 Power supply
- 9 Drain screw
- 10 Ventilation openings

Operating unit



- 1 Display
- 2 LEDs
- 3 Display buttons
- 4 Mains switch

Fig. 5: Operating unit

3.3 Operating elements

3.3.1 Mains switch

The mains switch can be set to the following positions:

- Position [I] switches the device on.
- Position [O] switches the device off.

3.3.2 Display buttons

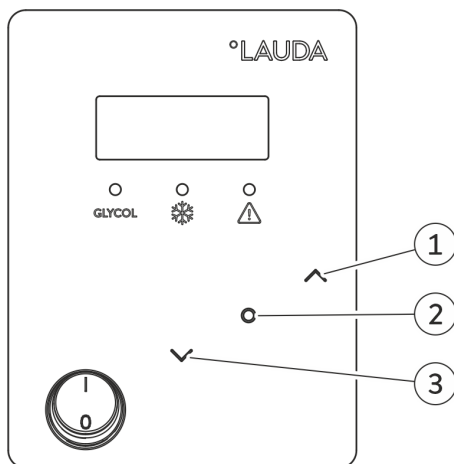

- 1 Up arrow button
- 2 Enter key
- 3 Down arrow button

Functions in the device display can be controlled by means of the display buttons.

- The Enter button can be used to confirm a selection in the display.
- The up and down arrow buttons can be used to navigate in the display.

Fig. 6: Display buttons

3.4 Functional elements

3.4.1 LEDs for function display

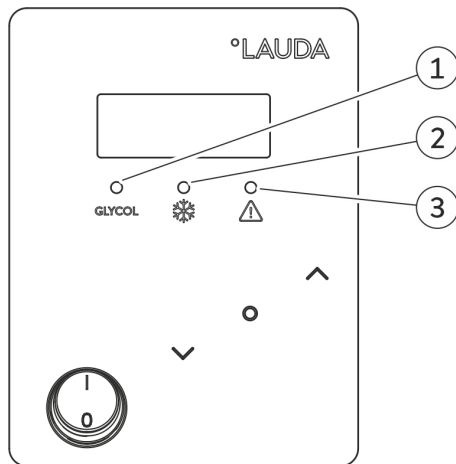

- 1 yellow LED
- 2 Blue cooling LED
- 3 Red error LED

Each device has three LEDs with the following functions:

- The yellow LED is lit if Kryo 30 is required as a heat transfer liquid.
- The blue cooling LED indicates whether the cooling unit is active.
- The red error LED is lit if the device has an error.

Fig. 7: LEDs

3.4.2 Hydraulic circuit

Hydraulic circuit

The hydraulic circuit refers to the circuit that the heat transfer liquid flows through.

The circuit essentially consists of the following components:

- Internal storage tank with heat transfer liquid
- Pump for conveying the heat transfer liquid to the external consuming unit via the pump connections
- From MC 600 on, the devices are equipped with an adjustable bypass to adjust the pump pressure to the requirements of the external consuming unit.

Pump

The devices are equipped with a magnetically coupled pressure pump.



You will find further information on the technical data of the pump and the pump characteristics in ↗ Chapter 11.4 “Hydraulic circuit” on page 52.

3.4.3 Pressure gage



Fig. 8: Pressure gage

The device types with a bypass are equipped with a pressure gage for reading the set pump pressure. The pump pressure is regulated via the bypass adjusting wheel. The bypass adjusting wheel is located on the back of the device.

3.4.4 Level indication

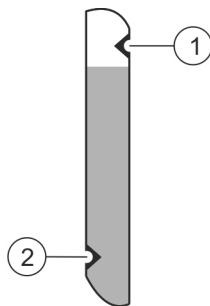

Fig. 9: Level indication

The fill level of the heat transfer liquid in the circuit can be read via the level indication.

- The maximum liquid level of the device is indicated via the top arrow.
 - The minimum liquid level of the device is indicated via the bottom arrow.
- 1 Maximum level
 - 2 Minimum level

3.4.5 Cooling unit

The cooling unit consists of the following main components:

- Compressor
A fully hermetically encapsulated compressor is used in the cooling unit. The compressor is equipped with a thermal cutout which reacts to the temperature and current consumption of the compressor.
- Condenser
The condensation heat is discharged to the environment in the case of air-cooled condensers. Fresh air is drawn in through the front of the device by means of a fan, heated and then discharged at the back of the device for this purpose.
- Evaporator
Heat is dissipated from the bath by means of a tube coil evaporator in the case of an internal bath.



You will find technical data on the cooling unit in ↗ Chapter 11.2 “Cooling unit” on page 51.

3.4.6 Interfaces

Please note the following:

- The equipment connected to the extra-low voltage inputs and outputs must be reliably isolated from voltages dangerous to the touch in accordance with DIN EN 61140. For example, by double or reinforced insulation according to DIN EN 60730-1 or DIN 60950-1.

RS 232 interface

You can use the RS 232 interface to control certain device functions, such as set temperature, on a PC. This allows individual programs to be developed to control the device.



You will find further information on the connection and configuration in ↗ Chapter 6.7.3 “Cable test and interface test of RS 232” on page 38 and ↗ Chapter 6.7.1 “Configuring the RS 232 interface” on page 37.

Alarm output

Change-over contact which is switched in the event of a fault in the device. Faults can therefore be reported e.g. to a system.



The fault situations in which a signal is output via the interface can be set via the display.

3.5 Rating label

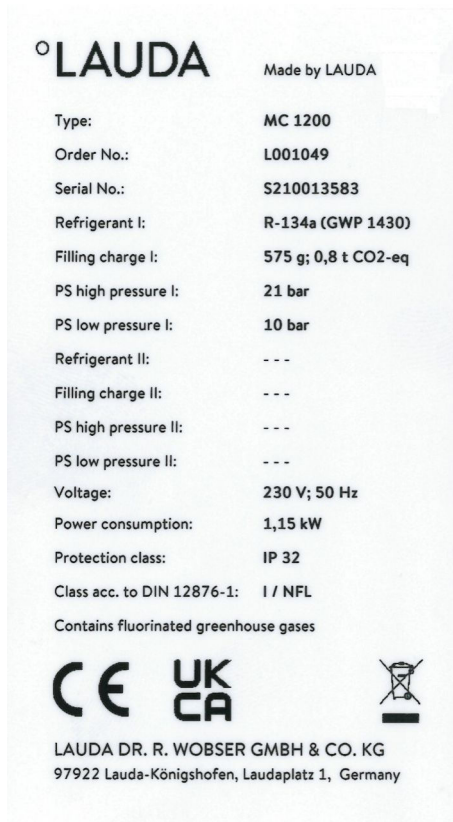

The specifications on the rating label are described in more detail in the following table. Certain specifications depend on the installed device options. These specifications are marked with a corresponding addendum.

Specification	Description
Type	Device type
Catalog no.	Catalog number of the device
Serial no.	Serial number of the device
Voltage	Device may only be operated with this distribution voltage and frequency
Refrigerant I	Designation of the refrigerant used in level 1 of the refrigerating machine
Filling charge I	Filling charge of the refrigerating machine
PS high pressure I	Maximum permitted working pressure on the refrigerant high-pressure side
PS low pressure I	Maximum permitted working pressure on the refrigerant low-pressure side
Power consumption	Maximum power consumption of the device during operation
Protection level	IP protection level of the device

Fig. 10: Rating label, example

4 Before starting up

4.1 Install device

Special installation conditions apply to the devices. These installation conditions are specified for the most part in the technical data for the device.



You will find further information on the technical data in
↳ Chapter 11.1 “General data” on page 50.

Additional installation conditions are described in the following.

- Irritant vapors may develop, depending on the heat transfer liquid and operating mode used. Always ensure that the vapors are adequately extracted.
- Note the electromagnetic compatibility (EMC) requirements of the device.
- Do not cover the ventilation openings.



You will find further information on the EMC requirements in
↳ Chapter 1.4 “EMC requirements” on page 7.



WARNING!
Danger of the device rolling away or overturning

Impact, crushing

- Do not tilt the device!
- Position the device on an even, non-slip surface with a sufficient load carrying capacity!
- Actuate the caster brake when setting up the device!
- Do not place heavy parts on the device!

1. Place the device in a suitable location in the room.
 - Place table-top devices on a suitable table. To do so, carry the device with your hands holding the bottom of the device.
 - Place floor-standing devices on a suitable level surface.



Floor-standing devices can be moved. To do so, release the parking brakes on the casters by pushing the [Off] lever downwards.



You can position several devices next to each other.

2. Lock the casters in the case of floor-standing devices. To lock, press the [On] lever downwards.

4.2 External consuming unit

4.2.1 Hoses



CAUTION!

Risk of heat transfer liquid escaping during operation due to the use of unsuitable hoses

Cold burns

- Use hoses with a temperature resistance corresponding to the operating temperature range of the device.



CAUTION!

Contact with cold hoses

Cold burns

- Use insulated hoses for temperatures below 0 °C.



The hoses described below can be used for all heat transfer liquids approved for the devices.



You will find further information on the pump connections of the individual devices in [Chapter 11.4 "Hydraulic circuit"](#) on page 52.

Approved hoses, adapters and hose clips

Table 3: Hoses, non-insulated

Type	Hose nozzle	Maximum permissible pressure	Clear Ø in mm	Outer diameter in mm	Temperature range in °C	Catalog number
EPDM hose	10 mm	Devices with a maximum pump pressure of < 1 bar	9	11	10 – 90	RKJ 111
EPDM hose	½" (13 mm)	Devices with a maximum pump pressure of < 1 bar	12	14	10 – 90	RKJ 112
Rubber hose with fabric reinforcement	½" (13 mm)	up to 10 bar	13 (½")	19	-40 – 100	RKJ 031
Rubber hose with fabric reinforcement	¾" (19 mm)	up to 10 bar	19 (¾")	27	-40 – 100	RKJ 032

Table 4: Hoses, insulated at the factory

Type	Pump connections	Application area	Clear Ø in mm	Insulation thickness in mm	Temperature range in °C	Catalog number
EPDM hose, insulated	Hose nozzle 13 mm, M16 x 1	Devices with a maximum pump pressure of < 1 bar	12	9	-35 – 90	LZS 021

Table 5: Insulating hoses for subsequent insulation, length 1 m

Insulation catalog number	Temperature range in °C	Clear Ø in mm	Wall thickness in mm	Suitable for hose
RKJ 058	-50 – 105	19	17.5	RKJ 112
RKJ 024	-50 – 110	16	8	RKJ 112
RKJ 009	-50 – 110	23	8.5	RKJ 031
RKJ 013	-50 – 110	29	8.5	RKJ 032

Table 6: Adapter, suitable for MC 600 and MC 1200

Designation	Description	Catalog number
Hose fitting	¾" Union nut, ½" hose nozzle	LWZ 016
Hose fitting	¾" Union nut, 10 mm hose nozzle	LWZ 040

Table 7: Hose clips

Material	Ø from to in mm	Catalog number
Stainless steel	10 – 16	EZS 012
Stainless steel	12 – 22	EZS 013
Stainless steel	20 – 32	EZS 015

4.2.2 Connecting an external consuming unit



CAUTION!

Risk of heat transfer liquid escaping during operation due to open consuming unit

Cold burns

- Always use hydraulically sealed consuming units.

**CAUTION!****Risk of external hydraulic circuit bursting due to gage pressure**

Impacts, cutting, cold burns

- When laying the hoses, make sure they cannot kink.

Please note the following:

- Temperature control hoses: Always use the largest possible diameters and shortest possible hoses in the external circuit.
If the temperature control hose diameter is too narrow, the insufficient flow rate will cause a drop in temperature between the device and the external consuming unit. In this case, increase or decrease the temperature accordingly.
- Secure the temperature control hoses using hose clips.
- When external consuming units are positioned higher than the device, the external volume may run dry when the pump is switched off and air enters the external fluid circuit, even when the circuits are closed. There is then a danger that the device will overflow.
- If a hose breaks, cold liquid may leak out, thereby endangering people and materials.

5 Commissioning

5.1 LAUDA heat transfer liquids

Please note the following:

- The heat transfer liquids each cover a recommended temperature range and must be suitable for the temperature range associated with their application.
- The heat transfer liquid becomes more viscous in the lower limit of the temperature range and affects temperature stability as well as the pump power and cooling capacity. The formation of vapors and odors increases in the upper range. Therefore, only fully utilize the temperature range when absolutely necessary. In particular, ice forms with Aqua 90 (water), which can lead to the destruction of the device.
- Never use contaminated or degenerated heat transfer liquids.
- You can request a copy of the safety data sheets for the heat transfer liquid at any time, if necessary.

Table 8: Approved heat transfer liquids

LAUDA designation	Chemical characterization	Temperature range in °C	Viscosity (kin) in mm ² /s at (at 20 °C)	Viscosity (kin) in mm ² /s at temperature	Container size		
					Catalog number	5 L	10 L
Kryo 30	Monoethylene glycol/water mixture	-30 – 90	4	50 at -25 °C	LZB 109	LZB 209	LZB 309
Aqua 90	Decalcified water	5 – 90	1	---	LZB 120	LZB 220	LZB 320

Please note the following with regard to Kryo 30:

- The water content decreases during longer periods of operation at higher temperatures and the mixture becomes combustible (flash point at 119 °C). Check the mixing ratio using a hydrometer.

Heat transfer liquid, water

- The proportion of alkaline earth ions in the water must be between 0.71 mmol/L and 1.42 mmol/L (equivalent of 4.0 and 8.0 °dH). Harder water leaves limescale deposits in the device.
- The pH value of the water must be between 6.0 and 8.5.
- Due to their corrosive properties, distilled, deionized, fully desalinated (FD) water, or ocean water cannot be used. High-purity water and distillates are suitable as a medium after 0.1 g of soda (Na₂CO₃, sodium carbonate) is added for every liter of water.
- Avoid chlorine content in the water at all costs. Do not add chlorine to the water. Cleaning agents and disinfectants, for example, contain chlorine.
- The water must be free of impurities. Water with iron content is unsuitable due to rust formation and untreated river water is unsuitable due to algae growth.
- The addition of ammonia is not permitted.

5.2 Establishing a mains connection

Personnel: Operating personnel

 NOTICE! Use of impermissible mains voltage or mains frequency	
	Device damage
	<ul style="list-style-type: none"> ● Compare the rating label with the available mains voltage and mains frequency.

Please note the following:

- The mains plug disconnects the device from the power supply. The mains plug must be easy to identify and access.
- Only connect the device to a socket with a protective earth conductor (PE).

Note for electric installation on site:

- The devices must be protected with a 16 ampere circuit breaker fitted during installation.
- Exception: Devices with 13 ampere UK plugs.

5.3 Switching on the device and filling with heat transfer liquid

Fill mode

The device is provided with a software program (from and including software version 1.46) which supports the operator when filling the constant temperature equipment. If the fill level is too low, Fill mode is activated immediately after the device is switched on. *FILL* is shown in the display and the level indication is illuminated. The pump and the cooling unit are not started.

Personnel: Operating personnel

Protective equipment: Protective goggles
 Protective clothing
 Protective gloves

 DANGER! Use of incorrect heat transfer liquid	
	Fire
	<ul style="list-style-type: none"> ● Select a heat transfer liquid with a temperature range 20 K above the temperature range of the application!



WARNING!
Overflow of heat transfer liquid

Electric shock

- Do not overfill the device. Observe the level display and the thermal volume expansion of the heat transfer liquid.



WARNING!
Spraying of heat transfer liquid

Electric shock

- Do not spray heat transfer liquid. Use a funnel for filling.



NOTICE!
Overheating of the pump

Device damage

- Never operate the device without heat transfer liquid.

You have already connected the external consuming unit as described in Chapters ↗ Chapter 4.2.1 “Hoses” on page 23 and ↗ Chapter 4.2.2 “Connecting an external consuming unit” on page 24.



Please refer to Chapter ↗ Chapter 5.4 “Setting the pump pressure” on page 29 when using pressure-sensitive consuming units.

1. Close the drain screw. Turn the screw clockwise as far as it will go.
2. Turn the bypass control knob counterclockwise to the fully open position.
3. Attach a suitable hose to the overflow connection on the device.



The permissible hose diameter for the overflow must be complied with. More detailed information on the suitable hose diameter can be found in the technical data ↗ Chapter 11.4 “Hydraulic circuit” on page 52.

4. Place the end of this hose into a suitable canister to collect the overflowing heat transfer liquid.



If the pump is at a standstill and air enters the thermostatic circuit (e.g. due to an incompletely closed or defective vent valve), the consuming unit can run dry, even in a closed thermostatic circuit with a consuming unit in a higher position. Adjust the size of the overflow container to this if possible.

Fill level sufficient

5. Switch on the device at the mains switch.
 - ▶ A signal tone is emitted. The software version is shown in the display. The actual temperature is then shown in the display.

The constant temperature equipment starts operation, the pump is started.

Depending on the set temperature, the cooling unit is started after 2 minutes at the earliest. The blue LED is lit if the cooling unit is active.

Fill level too low (low level)

6. Switch on the device at the mains switch.
 - ▶ A signal tone is emitted. The software version is shown in the display. *FILL* is then shown in the display. The pump and the cooling unit are not started if the level is low.

Fill the device with heat transfer liquid.
7. Carefully pull the cover on the filler nozzle upwards, do not twist it.
8. Carefully pour heat transfer liquid into the filler nozzle. Monitor the level indication. Fill the device to the maximum fill level.



Use a funnel for filling if required.



The level indication must not be above the maximum fill level.

Fill level falls

9. Press the **Enter key** when the maximum or a sufficient fill level is reached.
 - ▶ The pump starts. The actual temperature is shown in the display. The fill level falls as the consuming unit is filled.
10. Carefully top up the heat transfer liquid, as the consuming unit is now being filled. If the fill level falls too low, the device switches automatically to FILL mode and the pump and the cooling unit are switched off. Continue filling until trouble-free operation is possible. Monitor the level indication.
11. Carefully press the cover in the filler nozzle.

5.4 Setting the pump pressure

The pump pressure can be adjusted via a control valve on the rear of the device in devices with a bypass (MC 600 and MC 1200). The pump pressure can therefore be set individually for pressure-sensitive external consuming units.



Open the bypass adjusting wheel on the back of the device to the full extent before switching the device on.

Turn the adjusting wheel counterclockwise to open.

Personnel: ■ Operating personnel



CAUTION!
Risk of external consumer bursting

Cold burns, impacts, cutting

- A bypass controller is provided to set the pump pressure (from MC 600).
- Use a safety valve for the protection of consuming units with a maximum permissible working pressure below the maximum pressure of the pump. This safety valve must be installed in the outflow of the device.

1. To increase the pressure in the consuming unit, turn the bypass adjusting wheel clockwise until the desired pressure (< than the permissible pressure) for the external consuming unit is reached.



Monitor the display on the pressure gage.

6 Operation

6.1 Switching on the device

 NOTICE! Overheating of the pump
Device damage
<ul style="list-style-type: none"> ● Never operate the device without heat transfer liquid.

Personnel: ■ Operating personnel

1. Switch on the device at the mains switch.
 - ▶ A signal tone is emitted. The software version is shown in the display. The actual temperature is then shown in the display.

The constant temperature equipment starts operation, the pump is started.

Depending on the set temperature, the cooling unit is started after 2 minutes at the earliest. The blue LED is lit if the cooling unit is active.
2. Heat transfer liquid may have to be topped up depending on the size of the consuming unit. Monitor the level indication.

 Refer to ↩ Chapter 5.3 “Switching on the device and filling with heat transfer liquid” on page 27 for detailed information on topping up the heat transfer liquid.

6.2 Basic display and menu items

1. Press the Enter key to go to the menu items from the basic display, i.e. the actual temperature.

 The menu item or the input window is exited if you do not press a key for more than 4 seconds.

2. Use the arrow keys to scroll from menu item to menu item.
3. Press the Enter key at the selected menu item.
 - ▶ The display flashes.
4. Use the arrow keys to change the value or setting.
5. Immediately accept the changed value or setting by pressing the Enter key.

 Changed values or settings are automatically applied and the menu item or input window is exited if you do not press a key for more than 4 seconds.

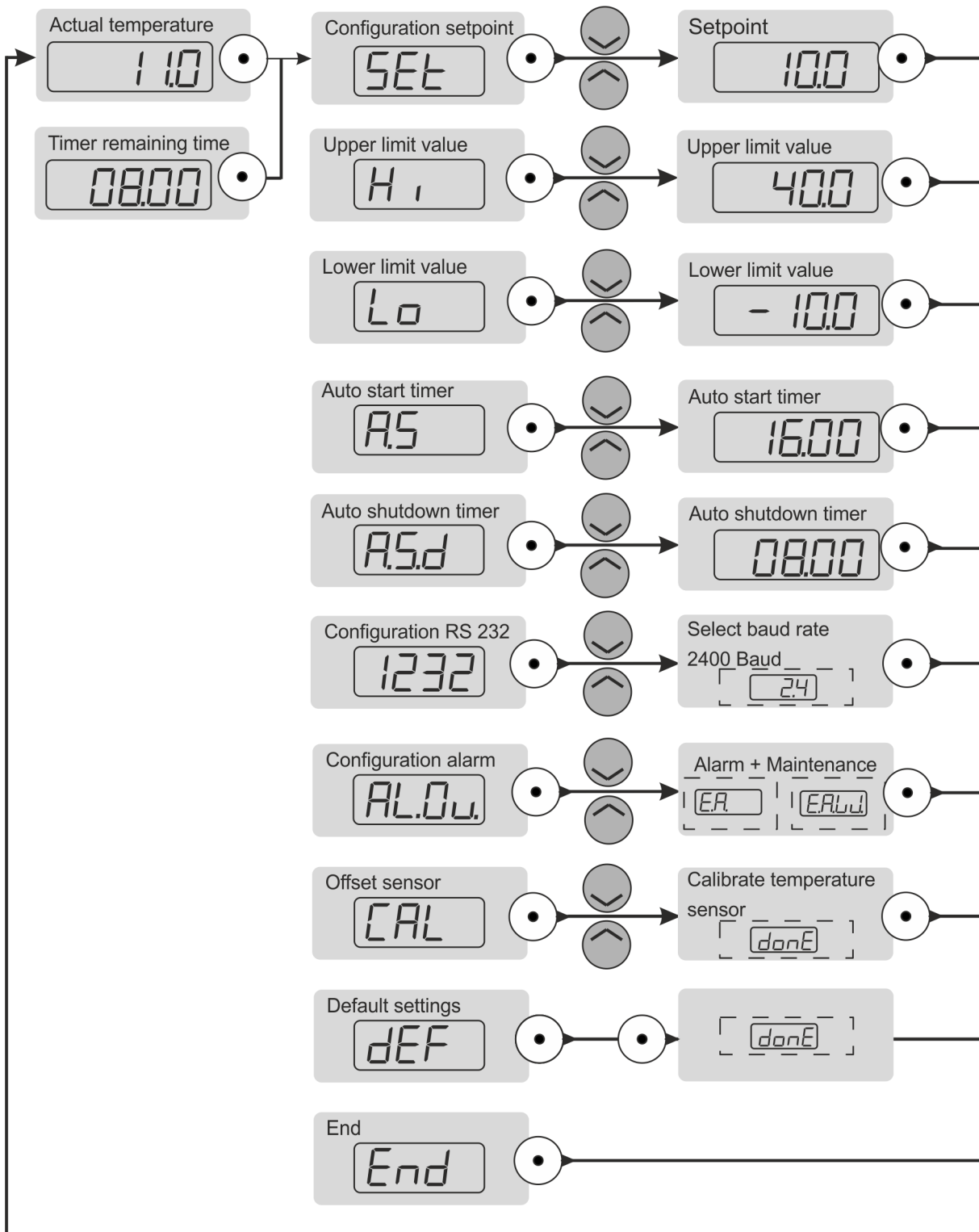

Fig. 11: Menu

6.3 Indications in the display

Basic display



Fig. 12: Basic display

The basic display is the indication in the display which is shown unless other operations such as configuring settings are performed. The actual temperature of the device in °C is shown in the basic display.

Menu

The Enter key can be used to call the menu of the device with possible settings.



You will find more information on the structure of the menu and how to navigate in the menu in [Chapter 6.2](#) “Basic display and menu items” on page 31.

Editing display

The display flashes if a menu item has been selected in the display. The setting can now be made. The entered value is accepted by confirming the setting.

6.4 Setting the temperature set point

Relationship between the temperature set point and the temperature limits

You set a temperature set point for the temperature control. This value specifies the temperature to which the heat transfer liquid is cooled. The upper and lower temperature limits of the device have default values of 45.0 °C and 5.0 °C respectively. The temperature limits define the temperature range of your application, i.e. the temperature range in which temperature control can take place. A warning is issued by the device outside the temperature limits. This range ensures that no unnecessary warnings are issued during transient processes of the temperature control. The defaults can be subsequently restricted depending on the heat transfer liquid.

Do not set the temperature set point lower than 5 °C when operating the device with Aqua 90. Also use the lower temperature limit value [Lo](#) “Lower temperature limit value” on page 34 and set it to 3 °C so that a warning is output at lower temperatures.

The yellow LED on the device is lit at a temperature set point or an actual temperature of less than 5 °C. It warns of incorrect use of the heat transfer liquid and the resulting damage to the device.



If the device is operated at liquid temperatures below 5 °C, Kryo 30 (glycol/water) must be used as the heat transfer liquid for the device

Personnel: Operating personnel

1. Select the menu item for specifying the temperature set point.
2. Specify the set point value.

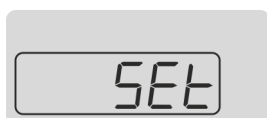

Fig. 13: Set point entry



The value cannot be accepted if the set point entered is outside the set temperature limits. The editing mode is active. An acoustic signal is also emitted. You can enter the set point again.

3. Press the input button to confirm.

6.5 Restricting the temperature limits

You must limit the temperature limit value range for safety reasons. These two values depend on the heat transfer liquid used. The default settings 45.0 °C and 5.0 °C are stored in the device and cannot be changed.

Appropriate temperature limit values are:

- | | |
|----------------------------|-------------------------------------------------|
| Aqua 90 | - Set the range to the values 42 °C and 3 °C. |
| Kryo 30 (water/
glycol) | - Set the range to the values 42 °C and -12 °C. |



Adjusting the temperature limit values automatically limits the adjustable set point range to 2 °C below the upper temperature limit and 2 °C above the lower temperature limit.

Upper temperature limit value

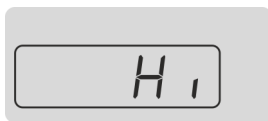

Fig. 14: Upper limit

Personnel: Operating personnel

1. Select the menu item for the upper temperature limit value.
2. Press the input button to confirm.
3. Specify the upper limit.



The maximum value for the upper limit is 45 °C.

4. Press the input button to confirm.

Lower temperature limit value

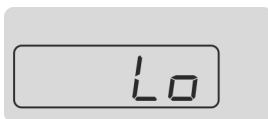

Fig. 15: Lo. limit

Personnel: Operating personnel

1. Select the menu item for the lower temperature limit value.
2. Press the input button to confirm.
3. Specify the lower limit.



The minimum value for the lower limit is 5 °C when using Aqua 90 and -15 °C when using Kryo 30.

4. Press the input button to confirm.

6.6 Configuring the clock timer

The integrated clock timer can be used to switch the device on and off automatically. The clock timer can be viewed and configured during normal operation of the device.

Special features of the clock timer

- The clock timer is configured by a number of hours and minutes in the format hh.mm. The first two digits represent the number of hours, the last two represent the number of minutes. The clock timer can be set to a maximum of 99 hours and 59 minutes.
- The clock timer is only active as long as the device is switched on. If the device is switched off via the mains switch during the runtime of the clock timer, the clock timer is reset.

Functions of the clock timer

- If the clock timer is active, the current actual temperature is indicated by a flashing dot in the display.
- If the clock timer is called via the corresponding menu item, the remaining time period, e.g. 05.30, flashes on the display. If the clock timer is not active, 00.00 flashes on the display.
- If the time period of the auto shutdown function has elapsed, the device is not switched off completely, but switched to standby. Standby means that all components of the device are switched off, and only the device display is still supplied with power.

Functions for automatic switch-on - auto start

- If auto start of the clock timer has been configured, the device switches to standby and auto start becomes active immediately. If auto shutdown is active, auto start only becomes active after the auto shutdown has elapsed.
- If auto start is active, the remaining time period until the automatic start is shown in the display. An acoustic signal is also emitted during the entire last minute before the device is started.

Configuring auto shutdown

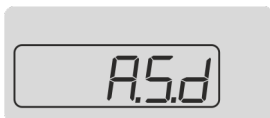

Fig. 16: Auto shutdown

1. Select the menu item for specifying auto shutdown.
2. Press the input button to confirm.
3. Specifies the time period from which the device is to be switched to standby.



Wait approx. 4 seconds if you do not wish to accept the specified value. The display will automatically return to the basic display.

4. Press the input button to confirm.



The value must be confirmed within 4 seconds of the last entry. Otherwise, the display will return to the basic display.

- ▶ The device is switched to standby after the entered time period. This is shown in the display as follows.

5. You can now configure auto start before auto shutdown elapses, in order to switch the device on again after a certain time. Otherwise, you can start the device manually by pressing the Enter key.

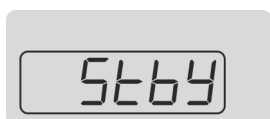

Fig. 17: Standby

Configuring auto start



Fig. 18: Auto start



CAUTION!
Automatic device start with the auto start timer

Cold burns, danger of injury, device damage

- Before using the auto start timer, ensure that all preparatory measures for intended use have been implemented!

1. Select the menu item for specifying auto start.
2. Press the input button to confirm.
3. Specifies the time period after which the device is to be switched on again.



If auto shutdown has not been configured for the device, the device is switched directly to standby when you confirm.



Wait approx. 4 seconds if you do not wish to accept the specified value. The display will automatically return to the basic display.

4. Press the input button to confirm.



The value must be confirmed within 4 seconds of the last entry. Otherwise, the display will return to the basic display.

Viewing and editing the remaining time period

1. Select the menu item for auto shutdown or auto start.
2. Press the input button to confirm.
 - ▶ The remaining time period is displayed.
3. The following options are available:
 - Wait approx. 4 seconds if you only wish to display the remaining time period. The basic display is shown again.
 - Set the time period accordingly to edit the remaining time period. Press the input button to confirm.

Resetting

1. Select the menu item for auto shutdown or auto start.
2. Enter 00.00.
3. Press the input button to confirm.



The value must be confirmed within 4 seconds of the last entry. Otherwise, the display will return to the basic display.

Switching on again manually

If the device was switched to standby via auto shutdown and auto start has not been configured, the device can be switched on again manually.

1. Press the Enter key to switch the device back on.



This function is only available if auto start is not active.

6.7 RS 232 interface

6.7.1 Configuring the RS 232 interface



Fig. 19: RS 232 interface

The baud rate for the RS 232 interface can be configured via the display.

Personnel: Operating personnel

1. Select the menu item for configuration of the RS 232 interface.
2. Select the desired baud rate.

The following baud rates can be selected:

- 2.4
- 4.8
- 9.6
- 19.2



The hundreds and thousands digits are not shown in the display.

3. Press the input button to confirm.



Your entry is automatically accepted after approx. 4 seconds.

6.7.2 Protocol

Protocol RS 232

Please note the following:

- The interface works with 1 stop bit, without a parity bit and with 8 data bits.
- Transmission speed alternately: 2400, 4800, 9600 (factory setting) or 19200 bauds.
- The RS 232 interface can be operated with or without hardware handshake (RTS/CTS).
- The command from the computer must be made with a CR, CRLF, or LFCR.
- The response from the thermostat is always made with a CRLF.
- After each command sent to the thermostat, it is necessary to wait for the reply before sending another command. This ensures that the sequencing of inquiries and answers is clear.

CR = Carriage Return (Hex: 0D); LF = Line Feed (Hex: 0A)

Example

Table 9: Example for set value transfer from 30.5 °C to the thermostat.

Computer	Thermostat
"OUT_SP_00_30.5" CRLF	
	"OK" CRLF

6.7.3 Cable test and interface test of RS 232

Signal	Computer				Thermostat		Signal
	9-pin sub-D socket		25-pin sub-D socket		9-pin sub-D socket		
	With hardware handshake	Without hardware handshake	With hardware handshake	Without hardware handshake	With hardware handshake	Without hardware handshake	
RxD	2	2	3	3	2	2	TxD
TxD	3	3	2	2	3	3	RxD
DTR	4		20		4		DSR
Signal ground	5	5	7	7	5	5	Signal ground
DSR	6		6		6		DTR
RTS	7		4		7		CTS
CTS	8		5		8		RTS

Please note the following:

- With hardware handshake: When connecting a thermostat to the PC, use a 1:1 and not a null modem cable. The RS 232-interface can be connected directly to the PC using a 1:1 contacted cable.
- Without hardware handshake: Set the corresponding operation mode on the PC. Use protected connection lines. Connect the protective screen with the connector shell. The lines are galvanically separated from the rest of the electronics. Do not connect unassigned pins.
- It is easy to check the RS 232-interface when it is connected to a PC with a Microsoft Windows operating system.
For Windows® 3.11 with the program "Terminal".
For Windows® 95/98/NT/XP with the program "HyperTerminal".
For operating systems Windows Vista, Windows 7, and Windows 8 "HyperTerminal" is no longer part of the operating system.
- It is possible to communicate with the RS 232-interface using the LAUDA control and application software, Wintherm Plus (catalog number LDSM2002).
- Terminal programs are available on the Internet as freeware. These programs offer features similar to "HyperTerminal" (for example PuTTY). Search query "serial port terminal program".

6.7.4 Write commands

Write commands are data specifications for the thermostat.

Command	Meaning
OUT_SP_00_XXX.XX	Set point transfer with a max. 3 places in front of the decimal point and a max. 2 places after
OUT_SP_04_XXX	[Hi] Outflow temperature limit upper value
OUT_SP_05_XXX	[Lo] Outflow temperature limit lower value
START	Switches the device on (from standby)
STOP	Switches the device to standby (pump, cooling unit off)

Please note the following:

- " " (blank space) can also be used for "_".
- Response from thermostat will be "OK", or "ERR_X" if there is an error.

Acceptable data formats

-XXX.XX	-XXX.X	-XXX.	-XXX	XXX.XX	XXX.X	XXX.	XXX
-XX.XX	-XX.X	-XX.	-XX	XX.XX	XX.X	XX.	XX
-X.XX	-X.X	-X.	-X	X.XX	X.X	X.	X
-.XX	-.X	.XX	.X				

6.7.5 Read commands

The following read commands are data requests to the thermostats.

Command	Meaning
IN_PV_00	Query bath temperature (flow temperature)
IN_SP_00	Query temperature target value
IN_SP_04	Query of outflow temperature limit Hi
IN_SP_05	Query of outflow temperature limit Lo
TYPE	Query of the device type (answer = "MC")
VERSION	Query of software version number

Command	Meaning
STATUS	Query device status 0 = OK, -1 = fault
STAT	Query of fault diagnosis response: XXXXXXXX; X = 0 no fault, X = 1 fault 1 character = error 2 characters = not assigned 3 characters = not assigned 4 characters = not assigned 5 characters = low level 6 characters = not assigned 7 characters = not assigned

Please note the following:

- " " (blank space) can also be used for "_".
- If not otherwise specified in the command, the response will always be given in fixed point format "XXX.XX" or for negative values "-XXX.XX" or "ERR_X".

6.7.6 Error messages

The following is a description of the error messages of the modules.

Error	Description
ERR_2	Wrong entry (e.g. buffer overflow).
ERR_3	Wrong command
ERR_5	Syntax error in value
ERR_6	Impermissible value
ERR_32	The upper temperature limit is lower than or equal to the lower temperature limit.

6.8 Alarm output

6.8.1 Configuring the alarm output

The default setting is that an electrical signal is output via the alarm output of the device in the event of an alarm or error. However, you can also configure the system so that a signal is additionally output in the case of a warning.

Personnel: Operating personnel

1. Select the menu item for configuring the alarm output.



Fig. 20: Alarm output

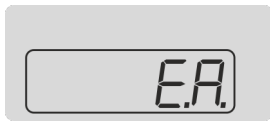

Fig. 21: Error and alarm option

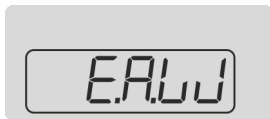

Fig. 22: Option with additional warning

2. Select the following option to output an electrical signal for alarms and errors.

3. Select the following option to output an additional electrical signal for warnings.



Wait approx. 4 seconds if you do not wish to accept the specified value. The display will automatically return to the basic display.

4. Press the input button to confirm.



The value must be confirmed within 4 seconds of the last entry. Otherwise, the display will return to the basic display.

6.8.2 Interface potential-free contact

- The contacts may be loaded with a maximum voltage of 30 V direct current (DC) and a maximum current of 0.2 A.

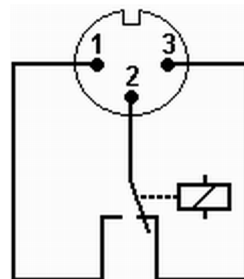

Fig. 23: Flange plug (front) in fault condition

View of the flange plug (front) or into the coupling socket on the soldering side.

Good condition

- Pin 1 and 2 are closed.
- During trouble-free operation, the alarm output is in good state.

Fault condition

- Pin 2 and 3 are closed.
- The alarm output is in fault condition:
 - If the device is switched off,
 - after switching on, if a fault (e.g. low level) is already present,
 - during operation, if a fault occurs, and
 - for each event configured in the *Alarm Output* menu.



You can find information on the settings for the alarm output in Chapter 6.8.1 “Configuring the alarm output” on page 40.

Please note the following:

- The equipment connected to the extra-low voltage inputs and outputs must be reliably isolated from voltages dangerous to the touch in accordance with DIN EN 61140. For example, by double or reinforced insulation according to DIN EN 60730-1 or DIN 60950-1.
- Only use protected connection lines. Connect the protective screen with the connector shell. Cover unused connectors with protective caps.

6.9 Enter the offset for the temperature probe



The factory calibration is overwritten during the adjustment.

If a temperature deviation is discovered during inspection of the device with a reference thermometer, the offset value (i.e. the additive part of the characteristic line) of the internal measurement chain can be adjusted or a 2-point calibration carried out with the menu item *Cal*.

A calibrated reference thermometer (e.g. from the LAUDA DigiCal series) with the desired degree of accuracy is required. In other respects, the factory calibration should not be changed.

The reference thermometer must, in accordance with the requirements of the calibration certificate, be incorporated into the outflow of the device.

Personnel: ■ Operating personnel

1. Select the menu item for the adjustment.
2. Enter the temperature value read off the reference thermometer into the device.
3. Then press and hold the Enter key for about 3 seconds.
 - ▶ *donE* appears in the display. The new value has been accepted.

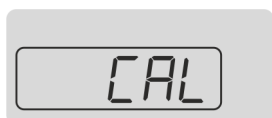

Fig. 24: Adjusting the temperature sensor

6.10 Restore factory setting

Use this menu item to restore the factory settings in the device.

- The range of the temperature limit values is reset to 45 °C and 5 °C.
- The timers are reset to 00.00 .
- The signal output is reset to *alarms and errors* at the alarm output.
- The baud rate is reset to 9600 *baud* .



Fig. 25: Factory setting

Personnel: Operating personnel

1. Select the menu item for restoring the factory setting.
2. (Briefly) press the input button to confirm.
3. Press and hold down the Enter key for about 3 seconds.
 - ▶ *donE* appears in the display. The factory setting has been restored.

7 Maintenance

7.1 General safety instructions



DANGER!
Contact with live or moving parts

Electric shock, impacts, cutting, crushing

- The device must be disconnected from the mains power supply before any kind of maintenance is performed.
- Only skilled personnel are permitted to perform repairs.



CAUTION!
Contact with hot / cold device parts, accessories and heat transfer liquid

Burns, scalding, cold burns

- Bring device parts, accessories and heat transfer liquid to room temperature before touching them.

Please also note the following:

- Before conducting maintenance work, ensure that the device has been decontaminated after coming into contact with hazardous materials.

7.2 Maintenance intervals

The maintenance intervals described in the following table must be observed. The following compulsory maintenance tasks must be performed before operating the device for prolonged periods.

Interval	Maintenance work
daily	External visual inspection of the drain screw
Monthly	Inspect the external hoses for material fatigue
	Clean the condenser
Six monthly	Check the heat transfer liquid

7.3 Cleaning the device

Personnel: Operating personnel



WARNING!
Risk of cleaning agent entering the device

Electric shock

- Only use a slightly damp cloth for cleaning.

Please also note the following:

- Only use water and detergent to clean the control panel. Do not use acetone or solvent, as these substances will permanently damage the plastic surfaces.

7.4 Cleaning the air-cooled condenser

Personnel: Operating personnel

1. Switch off the device.
2. Remove the front panel by grasping the bottom with both hands and pulling the grille forward. Remove the front panel slowly and carefully to avoid damage.
3. Brush off or vacuum the condenser.
4. Install the front panel again with care.

7.5 Check the heat transfer liquid

Contaminated heat transfer liquid must be replaced. Continued use of the heat transfer liquid is only permitted following successful testing.

The heat transfer liquid must be tested as outlined in DIN 51529.

8 Faults

8.1 Alarms, errors and warnings

All alarms, error messages and warnings triggered on the device appear on the display as a 7-segment text.

Procedure in event of alarm

Once the cause of the fault has been eliminated, the alarm can be canceled with the Enter key.

A list of alarms can be found in [↪ Chapter 8.2 “Overview of alarms”](#) on page 47.

Procedure in event of warning

Once the cause of the fault has been eliminated, the warning can be canceled with the Enter key.

A list of warnings can be found in [↪ Chapter 8.3 “Overview of warnings”](#) on page 47.

Procedure in event of error

If an error occurs, the device emits a two-tone acoustic signal. In addition, the red LED on the device is lit.



If this happens, switch off the device at the mains switch. If the error occurs again after switching on the device, make a note of the error code and contact the LAUDA Constant Temperature Equipment Service department. You will find the contact information in [↪ Chapter 12.3 “Contact LAUDA”](#) on page 53.



Errors are symbolized with an E and a consecutive three-digit number.



8.2 Overview of alarms

Alarms affect safety. The components of the device, such as the pump, switch off. The device emits a two-tone acoustic signal. In addition, the red LED on the device is lit.

Output in the display	Description
	In the case of a low-level alarm, the level of the heat transfer liquid is below the minimum limit. Where required, the fault which caused this low level must be remedied to clear the alarm. The heat transfer liquid must also be topped up. Warnings are output before the alarm is output. The alarm is output after approx. 5 minutes.
	The pump is blocked in the case of a pump alarm. This may be due to an impermissibly high viscosity of the heat transfer liquid or a foreign body in the circuit.
	The temperature of the electronics is higher than 75 °C.

8.3 Overview of warnings

Warnings do not have a significant effect on safety. The device continues to operate. The device will make a continuous noise for a short period of time. Warnings are issued periodically. You will therefore be reminded of an active fault.

Indication in the display	Description
	In the case of a low-level warning, the level of the heat transfer liquid is below the minimum limit. Where required, the fault which caused this low level must be remedied to clear the warning. The heat transfer liquid must also be topped up. If this warning is ignored, a low level alarm is issued after approx. 5 minutes and the components of the device, such as the pump, are switched off.
	This warning means that the upper temperature limit has been exceeded. The device fault must be remedied to clear this warning.
	This warning means that the lower temperature limit has been exceeded. The device fault must be remedied to clear this warning.

9 Decommissioning

9.1 Draining the device

Personnel: Operating personnel



WARNING!
Contact with cold heat transfer liquid

Cold burns

- Bring the heat transfer liquid to room temperature before draining.

Please also note the following:

- Observe the regulations for the disposal of used heat transfer liquid.
1. Switch off the device.
 2. Allow the device and heat transfer liquid to cool down or warm up to room temperature.
 3. Place a container with an appropriate capacity directly under the drain screw.



The heat transfer liquid flows out of the device directly after the drain screw is opened.

4. Open the drain screw. To do so, turn it counterclockwise.

10 Disposal

10.1 Disposing of refrigerant

Disposal of refrigerant must proceed according to regulation 2015/2067/EU in combination with regulation 517/2014/EU.



CAUTION!
Uncontrolled escape of refrigerant

Impacts, cutting

- Never dispose of a cooling circuit that is still pressurized.
- Only specialized personnel are permitted to perform disposal work.



The type and refrigerant charge are printed on the rating label.

10.2 Device disposal



The following applies for EU member states: The device must be disposed of according to Directive 2012/19/EU (WEEE Waste of Electrical and Electronic Equipment).

10.3 Disposing of packaging

Disposal of the packaging must be carried out in accordance with EC Directive 94/62/EC.

11 Technical data

11.1 General data



The device sound pressure level is below 70 dB. According to EC Directive 2006/42/EC the sound pressure level of the devices is therefore not specified further.

Specification	Value	Unit
Installation	Interior rooms	
Installation altitude above sea level	up to 2,000	m
Air humidity	maximum relative humidity of 80 % at 31 °C and decreasing linearly to 50 % up to 40 °C	
Ambient temperature range	5 – 40	°C
IP protection level	IP 32	
Pollution degree	2	
Clearance (front and back)	40	cm
Surge	Surge category II and transient surges according to category II	
Protection class for electrical equipment DIN EN 61 140 (VDE 0140-1)	1	
Classification according to DIN 12 876-1 (class designation/markings)	I/NFL	
Display	7-segment, LED	
Display resolution	0.1	°C
Setting resolution	0.1	°C
Temperature stability	±0.5	K
Storage temperature range	5 – 40	°C
Transportation temperature range	-20 – 60	°C

	Working temperature range	Dimensions (W x D x H)	Weight
	°C	mm x mm x mm	kg
MC 250	-10 – 40	200 x 350 x 465	28
MC 350	-10 – 40	240 x 400 x 500	36
MC 600	-10 – 40	350 x 480 x 595	52
MC 1200	-10 – 40	450 x 550 x 650	64

11.2 Cooling unit

Table 10: Cooling capacity

	Unit	MC 250	MC 350	MC 600	MC 1200
Cooling capacity (at 20 °C)	kW	0.25	0.35	0.60	1.20
Cooling capacity (at 10 °C)	kW	0.20	0.28	0.50	1.05
Cooling capacity (at 0 °C)	kW	0.15	0.22	0.36	0.75
Cooling capacity (at -10 °C)	kW	0.09	0.16	0.15	0.40



The cooling output is measured when the heat transfer liquid reaches a certain temperature. These temperature values are specified in brackets. The ambient temperature for the measurement is 20 °C and ethanol was used as a heat transfer liquid. To measure water-cooled devices, the cooling water temperature is 15 °C and the cooling water differential pressure is 3 bar.

11.3 Refrigerant and filling charge

The device contains fluorinated greenhouse gases.

Table 11: Devices with 230 V; 50 Hz

	Unit	MC 250	MC 350	MC 600	MC 1200
Refrigerant	---	R-134a	R-134a	R-134a	R-134a
Maximum filling weight	kg	0.085	0.095	0.295	0.575
GWP _(100a) *	---	1430	1430	1430	1430
CO ₂ equivalent	t	0.1	0.1	0.4	0.8

Table 12: Devices with 220 V; 60 Hz

	Unit	MC 250	MC 350	MC 600	MC 1200
Refrigerant	---	R-134a	R-134a	R-134a	R-134a
Maximum filling weight	kg	0.08	0.097	0.285	0.63
GWP _(100a) *	---	1430	1430	1430	1430
CO ₂ equivalent	t	0.1	0.1	0.4	0.9

Table 13: Devices with 115 V; 60 Hz

	Unit	MC 250	MC 350	MC 600	MC 1200
Refrigerant	---	R-134a	R-134a	R-134a	R-134a
Maximum filling weight	kg	0.08	0.095	0.225	0.585

	Unit	MC 250	MC 350	MC 600	MC 1200
GWP _(100a) *	---	1430	1430	1430	1430
CO ₂ equivalent	t	0.1	0.1	0.3	0.8

Table 14: Devices with 100 V; 50/60 Hz

	Unit	MC 250	MC 350	MC 600	MC 1200
Refrigerant	---	R-134a	R-134a	R-134a	R-134a
Maximum filling weight	kg	0.092	0.095	0.31	0.57
GWP _(100a) *	---	1430	1430	1430	1430
CO ₂ equivalent	t	0.1	0.1	0.4	0.8



Global Warming Potential (GWP), CO₂ comparison = 1.0

* Time frame 100 years - according to IPCC IV

11.4 Hydraulic circuit

		MC 250	MC 350	MC 600	MC 1200
Filling volume	L	2 – 4	4 – 7	4 – 8	7 – 14
maximum flow rate	l/min (water 20 °C)	16	16	35	35
Maximum discharge pressure	bar (water 20 °C)	0.35	0.35	1.30	1.30
Pump connection	(clear Ø in mm)	Hose nozzle ½" (10)	Hose nozzle ½" (10)	G ¾ (15), hose nozzle ¾"	G ¾ (15), hose nozzle ¾"
Drain tap	Connection	G ½"	G ½"	G ½"	G ½"
Overflow connection	(clear Ø in mm)	Hose nozzle ½" (10)	Hose nozzle ½" (10)	Hose nozzle 16 mm (12)	Hose nozzle 16 mm (12)

11.5 Voltage-dependent data

Table 15: Power consumption

	MC 250	MC 350	MC 600	MC 1200
	kW	kW	kW	kW
230 V; 50 Hz	0.23	0.50	0.70	1.15
220 V; 60 Hz	0.23	0.50	0.70	1.15
115 V; 60 Hz	0.23	0.50	0.75	1.10
100 V; 50/60 Hz	0.23	0.50	0.75	1.10

12 General

12.1 Copyright

This manual is protected by copyright and only meant for internal use by purchasers.

The relinquishment of this manual to third parties, copying in any way whatsoever – even in the form of excerpts – and the utilization and/or conveyance of its content are not allowed, except for internal purposes, without written approval from the manufacturer.

Violation of this may obligate the violator to the payment of damages. Other claims reserved.

We point out that the designations and brand names of the respective companies used in the manual are generally subject to trademark, brand and patent protection.

12.2 Technical changes

The manufacturer reserves the right to make technical modifications to the device.

12.3 Contact LAUDA

Contact the LAUDA Service department in the following cases:

- Troubleshooting
- Technical questions
- Ordering accessories and spare parts

Please contact our sales department for questions relating to your specific application.

Contact information

LAUDA Service

Phone: +49 (0)9343 503-350

Fax: +49 (0)9343 503-283

Email: service@lauda.de

12.4 Declaration of Conformity



EC DECLARATION OF CONFORMITY

Manufacturer: LAUDA DR. R. WOBSEER GMBH & CO. KG
Laudaplatz 1, 97922 Lauda-Königshofen, Germany

We hereby declare under our sole responsibility that the machines described below

Product Line: Microcool **Serial number:** from CN210000001

Types: MC 250, MC 350, MC 600, MC 1200

comply with all relevant provisions of the EC Directives listed below due to their design and type of construction in the version brought on the market by us:

Machinery Directive	2006/42/EC
EMC Directive	2014/30/EU
RoHS Directive	2011/65/EU in connection with (EU) 2015/863

The equipment is not covered by the Pressure Equipment Directive 2014/68/EU, as the maximum classification of the equipment is Category 1 and it is covered by the Machinery Directive.

The protective objectives of the Machinery Directive with regard to electrical safety are complied with in accordance with Annex I Paragraph 1.5.1 in conformity with the Low Voltage Directive 2014/35/EU.

Applied standards:

- EN 12100:2011 (ISO 12100:2010)
- EN 61326-1:2013 (IEC 61326-1:2012)
- EN 378-2:2018
- EN 61010-1:2011 (IEC 61010-1:2010 + Cor.:2011)

Authorized representative for the composition of the technical documentation:

Dr. Jürgen Dirscherl, Director Research & Development

Lauda-Königshofen, 20.06.2022



Dr. Alexander Dinger, Head of Quality Management

*FAHRENHEIT. °CELSIUS. °LAUDA.

Document number: Q5WA-QA13-005-EN Version 07

12.5 Product Returns and Clearance Declaration

Product Returns

Would you like to return a LAUDA product you have purchased to LAUDA? For the return of goods, e.g. for repair or due to a complaint, you will need the approval of LAUDA in the form of a *Return Material Authorization (RMA)* or *processing number*. You can obtain the RMA number from our customer service department at +49 (0) 9343 503 350 or by email service@lauda.de.

Return address

LAUDA DR. R. WOBSE GMBH & CO. KG

Laudaplatz 1

97922 Lauda-Königshofen

Deutschland/Germany

Clearly label your shipment with the RMA number. Please also enclose this fully completed declaration.

RMA number	Product serial number
Customer/operator	Contact name
Contact email	Contact telephone
Zip code	Place
Street & house number	
Additional explanations	

Clearance Declaration

The customer/operator hereby confirms that the product returned under the above-mentioned RMA number has been carefully emptied and cleaned, that any connections have been sealed to the farthest possible extent, and that there are no explosive, flammable, environmentally hazardous, biohazardous, toxic, radioactive or other hazardous substances in or on the product.

Place, date	Name in block letters	Signature

13 Index

A	
Accessories	
In series	11
Adjustment (actual temperature)	
Determine	42
Air-cooled	
Cleaning condenser	45
Alarm	
Codes	47
Description	46
Arrow buttons (position)	18
C	
Checking	
Heat transfer liquid	45
Cleaning	45
CO2 equivalent	52
Code	
Alarms	47
Contact	53
Copyright	53
D	
Declaration of Conformity	54
Define temperature limits	34
Device	
Cleaning	45
Cleaning condenser (air-cooled)	45
Disposal (packaging)	49
Disposal (refrigerant)	49
Draining	48
Filling	27
Installation	22
Structure	14
Unpacking	11
Display buttons	
Operation	18
Disposal	
Packaging	49
Refrigerant	49
Disposing of refrigerant	49
Draining	
Device	48
E	
EMC	7
Error	
Description	46
Establish limit values (temperature)	34
Establishing a mains connection	27
Establishing a power supply	27
External consuming unit	
Connecting	24
F	
Factory setting	
Overview	42
Restore	42
FD water	26
Fill level	
Dropping	27
Low	27
Filling	27
Fully desalinated water	26
G	
GWP	52
H	
heat transfer liquid	
Removal	48
Heat transfer liquid	
Checking	45
Overview (approved)	26
Hydraulic circuit	
Description	18
I	
Input button (position)	18
Installation (device)	22
Installation location	22

Intended Use	6	Service	53
Interface	20, 38	Setting the temperature set point	33
configure	37	Soft keys (Position)	18
Protocol	37	Specifying the set point	33
L		Structure	
LED, yellow	33	Device	14
M		U	
Mains switch		Unpacking	11
Operation	17	W	
Maintenance		Warning	
interval	44	Description	46
O		Y	
Offset (actual temperature)		Yellow LED	33
Adjustment	42		
Overflow connection			
Hose	27		
Overflow hose	27		
P			
Packaging			
Disposal	49		
Personal protective equipment (overview)	9		
Personnel qualification (overview)	8		
Pressure gage			
Description	19		
Protective equipment (personal, overview)	9		
Pump pressure			
Setting	29		
R			
Rating label	14, 21		
Refrigerant			
Filling charge	52		
Filling weight	52		
RS 232	20, 38		
configure	37		
Protocol	37		
S			
Safety notice			
General	6		

Manufacturer

LAUDA DR. R. WOBSE GMBH & CO. KG ° Laudaplatz 1 ° 97922 Lauda-Königshofen

Telephone: +49 (0)9343 503-0 ° Fax: +49 (0)9343 503-222

E-mail: info@lauda.de ° Internet: <https://www.lauda.de>